

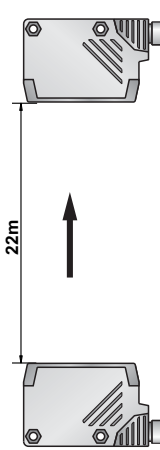







Thru-beam Mode

Sensing Mode	Connection	Supply Voltage	Output Mode	Part Number	
<p style="text-align: center;">Red Light: 660nm</p>  <p style="text-align: center;">Thru-beam Mode Sensing Distance: 22m</p>	<p>2m Cable</p> 	10-30V DC	Emitter	RP64-T022MD-EY6C3L2	
			NPN	RP64-T022MN-CY6C4U2	
			PNP	RP64-T022MP-CY6C4U2	
			NPN/PNP	RP64-T022MD-CY6C5U2	
		12-240V DC/ 24-240V AC	Emitter (2-wire)	RP64-T022MA-EY6C2L2	
			Relay L.O./D.O. (5-wire)	RP64-T022MR-CY6C5L2	
			SPST solid-state Light-ON (2-wire)	RP64-T022MG-LY6C2U2	
			SPST solid-state Dark-ON (2-wire)	RP64-T022MG-DY6C2U2	
		<p>Quick Disconnect (Pico-style)</p> 	10-30V DC	Emitter	RP64-T022MD-EY6Q4LP
				NPN	RP64-T022MN-CY6Q4UP
				PNP	RP64-T022MP-CY6Q4UP
				NPN/PNP	RP64-T022MD-CY6Q5UP
	12-240V DC/ 24-240V AC		_____	_____	
			_____	_____	
			_____	_____	
			_____	_____	
	<p>Quick Disconnect swivel 90°</p> 	10-30V DC (Euro style)	Emitter	RP64-T022MD-EY6Q4LE-S	
			NPN	RP64-T022MN-CY6Q4UE-S	
			PNP	RP64-T022MP-CY6Q4UE-S	
			NPN/PNP	RP64-T022MD-CY6Q5UE-S	
		12-240V DC/ 24-240V AC (Micro style)	Emitter (2-wire)	RP64-T022MA-EY6Q3LM-S	
			Relay L.O./D.O. (5-wire)	RP64-T022MR-CY6Q5LM-S	
			SPST solid-state Light-ON (2-wire)	RP64-T022MG-LY6Q3UM-S	
			SPST solid-state Dark-ON (2-wire)	RP64-T022MG-DY6Q3UM-S	
<p>6" Pigtail</p> 		10-30V DC (Euro style)	Emitter	RP64-T022MD-EY6P4LE	
			NPN	RP64-T022MN-CY6P4UE	
			PNP	RP64-T022MP-CY6P4UE	
			NPN/PNP	RP64-T022MD-CY6P5UE	
	12-240V DC/ 24-240V AC (Micro style)	Emitter (2-wire)	RP64-T022MA-EY6P3LM		
		Relay L.O./D.O. (5-wire)	RP64-T022MR-CY6P5LM		
		SPST solid-state Light-ON (2-wire)	RP64-T022MG-LY6P3UM		
		SPST solid-state Dark-ON (2-wire)	RP64-T022MG-DY6P3UM		

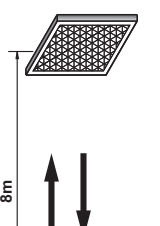
Note:
In Preparation: Part numbers with a line through the middle

Retroreflective Mode with Polarizing Filter

Sensing Mode	Connection	Supply Voltage	Output Mode	Part Number
<p style="text-align: center;">Red Light: 660 nm</p>  <p style="text-align: center;">8m</p> <p style="text-align: center;">Retro-reflective Mode with Polarizing Filter Sensing Distance: 8m (Note)</p>	<p>2m Cable</p> 	10-30V DC	NPN	RP64-L8000N-CY6C4U2-PF
			PNP	RP64-L8000P-CY6C4U2-PF
			NPN/PNP	RP64-L8000D-CY6C5U2-PF
		12-240V DC/ 24-240V AC	Relay L.O./D.O. (5-wire)	<u>RP64-L8000R-CY6C5L2-PF</u>
			SPST solid-state Light-ON (2-wire)	RP64-L8000G-LY6G2U2-PF
			SPST solid-state Dark-ON (2-wire)	RP64-L8000C-DY6C2U2-PF
	<p>Quick Disconnect (Pico-style)</p> 	10-30V DC	NPN	RP64-L8000N-CY6Q4UP-PF
			PNP	RP64-L8000P-CY6Q4UP-PF
			NPN/PNP	RP64-L8000D-CY6Q5UP-PF
		12-240V DC/ 24-240V AC	—	—
			—	—
			—	—
	<p>Quick Disconnect swivel 90°</p> 	10-30V DC (Euro style)	NPN	RP64-L8000N-CY6Q4UE-PS
			PNP	RP64-L8000P-CY6Q4UE-PS
			NPN/PNP	RP64-L8000D-CY6Q5UE-PS
		12-240V DC/ 24-240V AC (Micro style)	Relay L.O./D.O. (5-wire)	<u>RP64-L8000R-CY6Q5LM-PS</u>
			SPST solid-state Light-ON (2-wire)	RP64-L8000G-LY6Q3UM-PS
			SPST solid-state Dark-ON (2-wire)	RP64-L8000C-DY6Q3UM-PS
<p>6" Pigtail</p> 	10-30V DC (Euro style)	NPN	RP64-L8000N-CY6P4UE-PF	
		PNP	RP64-L8000P-CY6P4UE-PF	
		NPN/PNP	RP64-L8000D-CY6P5UE-PF	
	12-240V DC/ 24-240V AC (Micro style)	Relay L.O./D.O. (5-wire)	<u>RP64-L8000R-CY6P5LM-PF</u>	
		SPST solid-state Light-ON (2-wire)	RP64-L8000G-LY6P3UM-PF	
		SPST solid-state Dark-ON (2-wire)	RP64-L8000C-DY6P3UM-PF	





Note: Used with RE-6152 (supplied with sensor) reflector.

In Preparation: Part numbers with a line through the middle

Coming Soon : Part numbers with underline

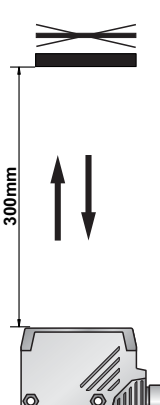
RP64 SERIES





Diffuse Mode with Background Suppression (Sn=300mm)

Sensing Mode	Connection	Supply Voltage	Output Mode	Part Number
<p style="text-align: center;">Red Light: 660nm</p>  <p style="text-align: center;">300mm</p> <p style="text-align: center;">Diffuse Mode with Background Suppression Sensing Distance: 300mm</p>	<p>2m Cable</p> 	10-30V DC	NPN	<u>RP64-D0300N-CY6C4U2-BS</u>
			PNP	<u>RP64-D0300P-CY6C4U2-BS</u>
			NPN/PNP	<u>RP64-D0300D-CY6C5U2-BS</u>
		12-240V DC/ 24-240V AC	Relay L.O./D.O. (5-wire)	<u>RP64-D0300R-CY6C5L2-BS</u>
			SPST solid-state Light-ON (2-wire)	<u>RP64-D0300G-LY6G2U2-BS</u>
			SPST solid-state Dark-ON (2-wire)	<u>RP64-D0300C-DY6G2U2-BS</u>
	<p>Quick Disconnect (Pico-style)</p> 	10-30V DC	NPN	<u>RP64-D0300N-CY6Q4UP-BS</u>
			PNP	<u>RP64-D0300P-CY6Q4UP-BS</u>
			NPN/PNP	<u>RP64-D0300D-CY6Q5UP-BS</u>
		12-240V DC/ 24-240V AC	—	—
			—	—
			—	—
	<p>Quick Disconnect swivel 90°</p> 	10-30V DC (Euro style)	NPN	<u>RP64-D0300N-CY6Q4UE-SB</u>
			PNP	<u>RP64-D0300P-CY6Q4UE-SB</u>
			NPN/PNP	<u>RP64-D0300D-CY6Q5UE-SB</u>
		12-240V DC/ 24-240V AC (Micro style)	Relay L.O./D.O. (5-wire)	<u>RP64-D0300R-CY6Q5LM-SB</u>
			SPST solid-state Light-ON (2-wire)	<u>RP64-D0300G-LY6Q3UM-SB</u>
			SPST solid-state Dark-ON (2-wire)	<u>RP64-D0300C-DY6Q3UM-SB</u>
<p>6" Pigtail</p> 	10-30V DC (Euro style)	NPN	<u>RP64-D0300N-CY6P4UE-BS</u>	
		PNP	<u>RP64-D0300P-CY6P4UE-BS</u>	
		NPN/PNP	<u>RP64-D0300D-CY6P5UE-BS</u>	
	12-240V DC/ 24-240V AC (Micro style)	Relay L.O./D.O. (5-wire)	<u>RP64-D0300R-CY6P5LM-BS</u>	
		SPST solid-state Light-ON (2-wire)	<u>RP64-D0300G-LY6P3UM-BS</u>	
		SPST solid-state Dark-ON (2-wire)	<u>RP64-D0300C-DY6P3UM-BS</u>	

Note:

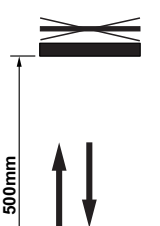
In Preparation: Part numbers with a line through the middle
 Coming Soon : Part numbers with underline — Ae-03 —

Diffuse Mode with Background Suppression (Sn=500mm)

Sensing Mode	Connection	Supply Voltage	Output Mode	Part Number
<p style="text-align: center;">Red Light: 660nm</p>  <p style="text-align: center;">500mm</p> <p style="text-align: center;">Diffuse Mode with Background Suppression Sensing Distance: 500mm</p>	<p>2m Cable</p> 	10-30V DC	NPN	<u>RP64-D0500N-CY6C4U2-BS</u>
			PNP	<u>RP64-D0500P-CY6C4U2-BS</u>
			NPN/PNP	<u>RP64-D0500D-CY6C5U2-BS</u>
		12-240V DC/ 24-240V AC	Relay L.O./D.O. (5-wire)	RP64-D0500R-CY6C5L2-BS
			SPST solid-state Light-ON (2-wire)	<u>RP64-D0500G-LY6G2U2-BS</u>
			SPST solid-state Dark-ON (2-wire)	<u>RP64-D0500C-DY6C2U2-BS</u>
	<p>Quick Disconnect (Pico-style)</p> 	10-30V DC	NPN	RP64-D0500N-CY6Q4UP-BS
			PNP	RP64-D0500P-CY6Q4UP-BS
			NPN/PNP	RP64-D0500D-CY6Q5UP-BS
		12-240V DC/ 24-240V AC	_____	_____
			_____	_____
			_____	_____
	<p>Quick Disconnect swivel 90°</p> 	10-30V DC (Euro style)	NPN	RP64-D0500N-CY6Q4UE-SB
			PNP	RP64-D0500P-CY6Q4UE-SB
			NPN/PNP	RP64-D0500D-CY6Q5UE-SB
		12-240V DC/ 24-240V AC (Micro style)	Relay L.O./D.O. (5-wire)	RP64-D0500R-CY6Q5LM-SB
			SPST solid-state Light-ON (2-wire)	<u>RP64-D0500G-LY6Q3UM-SB</u>
			SPST solid-state Dark-ON (2-wire)	<u>RP64-D0500C-DY6Q3UM-SB</u>
<p>6" Pigtail</p> 	10-30V DC (Euro style)	NPN	RP64-D0500N-CY6P4UE-BS	
		PNP	RP64-D0500P-CY6P4UE-BS	
		NPN/PNP	RP64-D0500D-CY6P5UE-BS	
	12-240V DC/ 24-240V AC (Micro style)	Relay L.O./D.O. (5-wire)	RP64-D0500R-CY6P5LM-BS	
		SPST solid-state Light-ON (2-wire)	<u>RP64-D0500G-LY6P3UM-BS</u>	
		SPST solid-state Dark-ON (2-wire)	<u>RP64-D0500C-DY6P3UM-BS</u>	

Note:

In Preparation: Part numbers with a line through the middle
 Coming Soon : Part numbers with underline — Ae-04 —

Specifications (DC)

Item	Sensing Mode		Thru-beam Mode	
	Diffuse Mode (with background suppression)	Retro-reflective Mode (with polarizing filter)	Emitter	Receiver
Sensing Range, Adjustable	100...300 mm (3.9...11.8 in) 150...500 mm (5.9...19.7 in)	8m (Note)	Max.: 22m(72.2 ft) Typical: 14m(45.9ft)	
Angle of Divergence	approx. 3.0°	approx.2.5°	approx.4.0°	
Light Spot Size	approx. 25mm @ 300mm approx. 35mm @ 500mm	approx. 400mm @ 8m (15.7 in @ 26.2 ft)	approx. 1.5m @ 20m (4.9 ft @ 65.6 ft)	
Light Source	LED Red			
Response Time/Frequency	<15 ms / 33 Hz	<0.7 ms / 700 Hz	<15 ms / 33 Hz	
Supply Voltage	10-30V DC (limit values)			
Current Consumption(no load)	<35 mA			
Ripple (within Vs tolerance)	< 5 V peak-to-peak			
Output Type	PNP, NPN, PNP+NPN			
Output Voltage High	PNP: Vs - (<=1.5V); NPN: approx. Vs.			
Output Voltage Low	PNP: approx. 0V; NPN: <=1.5V.			
Output Current Max.	100 mA			
Operation Mode	Selectable either Light-on Dark-on by the control input wire			
Connection	Cable or M12 4-pin plug			
Connecting Cable	PVC, 2m			
Housing Material	ABS			
Enclosure Rating	IP 67 / NEMA 6			
Circuit Protection	Outputs short circuit and over current protected, Vs reverse polarity protected			
Test Input	_____	_____	Vs: light source off, 0 V or no connection: light source on.	
Construction	IEC IP 66; NEMA1,3,4,12,13			
Ambient Operating Temperature	-25...55°C			
Storage Temperature	-40...70°C			
EMC	IEC 60947-5-2, Parts 7.2.6.1, 2.3 or RFI>3V/m (in 30-1000MHz), EFT>1KV, ESD>4KV(contact)			
Voltage with Stand Ability	IEC 60947-5-2, Part 8.3.3.4 or 500VDC for one min, between all supply terminals connected together and enclosure			
Insulation Resistance	>20MΩ , with 500V DC megger between all supply terminals connected together and enclosure			
Vibration Resistance	IEC 60947-5-2, Part 7.4.2 or 10-55HZ, 1.0mm amplitude in x , y and z directions for 30 min			
Shock Resistance	IEC 60947-5-2, Part 7.4.1 or 30g, 11ms in x , y and z directions for six time each			
Mounting Bracket	MB-7047 (optional)			
Weight	Approx. 140 g with plug; 162 g with cable			
Cable	2m or 9m 6.2ϕ 4X0.5 (Emitter :3X0.5) PVC.			
Pigtail Type	See Pigtail Series or our Cables & Connectors catalogue.			

Note: Used with RE-6152 (supplied with sensor) reflector.

Specifications (AC/DC)

Item	Sensing Mode	Diffuse Mode (with background suppression)	Retro-reflective Mode (with polarizing filter)	Thru-beam Mode	
				Emitter	Receiver
Sensing Range, Adjustable		100...300 mm (3.9...11.8 in) 150...500 mm (5.9...19.7 in)	8 m (Note)	Max.: 22m(72.2 ft) Typical: 14m(45.9ft)	
Angle of Divergence		Approx.3.0°	approx.2.5°	approx.4.0°	
Light Spot Size		approx. 25mm @ 300mm approx. 35mm @ 500mm	approx. 400mm @ 8m (15.7 in @ 26.2 ft)	approx. 1.5m @ 20m (4.9 ft @ 65.6 ft)	
Light Source	LED Red				
Response Time/Frequency		<15 ms / 33 Hz	<0.7 ms / 700 Hz	<15 ms / 33 Hz	
Supply Voltage	12-240V DC, 24-240V AC(10%)				
Power Consumption	<2 VA				
Output Type	Relay SPDT Isolated, SPST solid-state output				
Switching Voltage Max.	250V AC				
Switching Current Max.	3A				
Operation Mode	SPDT Relay Isolated: Selectable either Light-on Dark-on by the control input wire SPST solid-state: Only Light-ON or Dark-ON by type number				
Connection	Cable or M12 5-pin or 3-pin plug				
Connecting Cable	PVC, 2m				
Housing Material	ABS				
Enclosure Rating	IP 67 / NEMA 6				
Circuit Protection	Output Short Circuit Protection (Only for SPST Solid State output)				
Test Input	_____				
Ambient Operating Temperature	-25...55°C(-13...131°F)				
Storage Temperature	-40...70°C(-40...158°F)				
EMC	IEC 60947-5-2, Parts 7.2.6.1. 2.3 or RFI>3V/m (in 30-1000MHz), EFT>1KV, ESD>4KV(contact)				
Voltage with Stand Ability	IEC 60947-5-2, Part 8.3.3.4 or 1500VAC for one min, between all supply terminals connected together and enclosure				
Insulation Resistance	>20M Ω , with 1500V AC megger between all supply terminals connected together and enclosure				
Vibration Resistance	IEC 60947-5-2, Part 7.4.2 or 10-55HZ, 1.0mm amplitude in x , y and z directions for 30 min				
Shock Resistance	IEC 60947-5-2, Part 7.4.1 or 30g, 11ms in x , y and z directions for six time each				
Mounting Bracket	MB-7047 (optional)				
Weight	approx. 159g				
Cable	2m or 9m 6.2 ϕ 4X0.5 (Emitter :3X0.5) PVC.				
Pigtail Type	See Pigtail Series or our Cables & Connectors catalogue.				

Note: Used with RE-6152 (supplied with sensor) reflector.

Connection Diagrams

Emitter of Thru-beam Mode (DC)

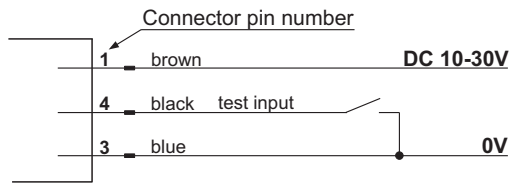

Connector face view

Euro-style

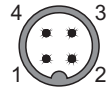

Pico-Style

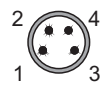

1. Brown (+)
2. Not used
3. Blue (-)
4. Black (Test input)

PNP

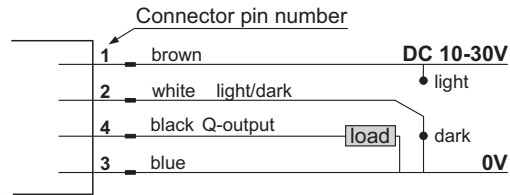

Connector face view

Euro-style

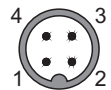

Pico-Style

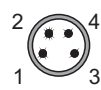

1. Brown (+)
2. White (Light/Dark control)
3. Blue (-)
4. Black (Output)

NPN

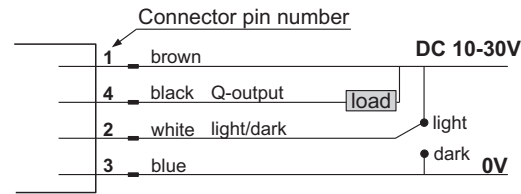

Connector face view

Euro-style

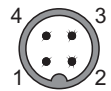

Pico-Style

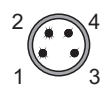

1. Brown (+)
2. White (Light/Dark control)
3. Blue (-)
4. Black (Output)

NPN/PNP

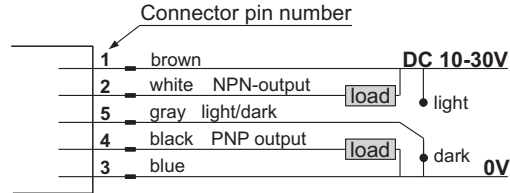

Connector face view

Euro-style

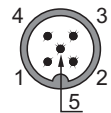

Pico-Style

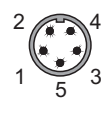

1. Brown (+)
2. White (NPN output)
3. Blue (-)
4. Black (PNP output)
5. Gray (Light/Dark control)

Emitter of Thru-beam Mode (AC)

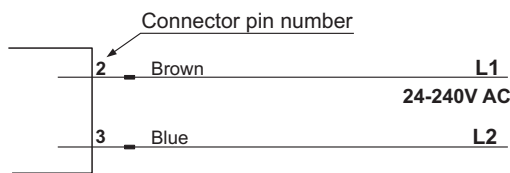

Connector face view

Micro-style

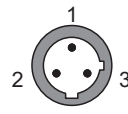

1. Green (Not used)
2. Red/black (L1)
3. Red/white (L2)

SPDT EM Relay version (AC/DC)

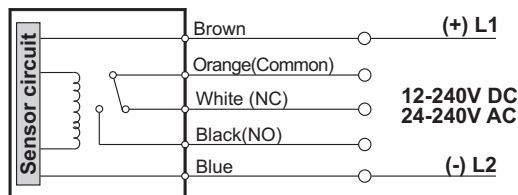

Connector face view

Micro-style

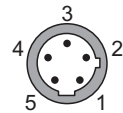

1. Red/white (L1)
2. Red (L2)
3. Green (Common)
4. Red/yellow (N.O.)
5. Red/black (N.C.)

SPST solid-state version (AC/DC)

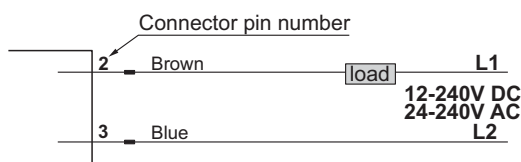

Connector face view

Micro-style

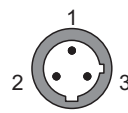

1. Green (Not used)
2. Red/black (L1)
3. Red/white (L2)

Sensing Characteristics (Typical)

BGS Type Diffuse Sensor (Sn=300mm)

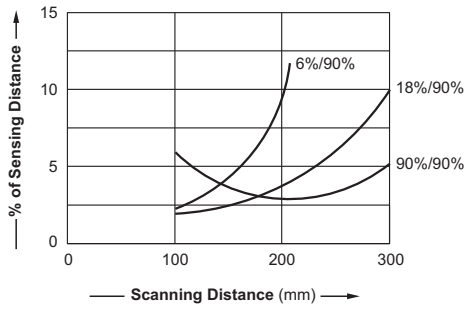

BGS Type Diffuse Sensor (Sn=500 mm)

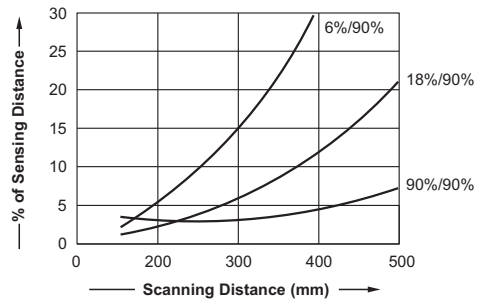

Retro-reflective Sensor (Sn=8m)

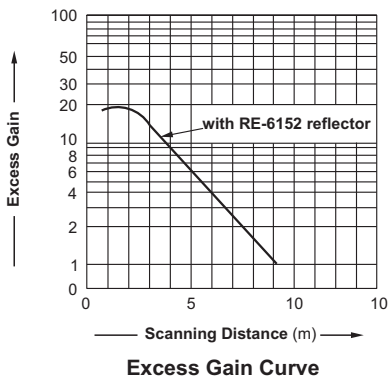

Thru-beam Sensor (22m)

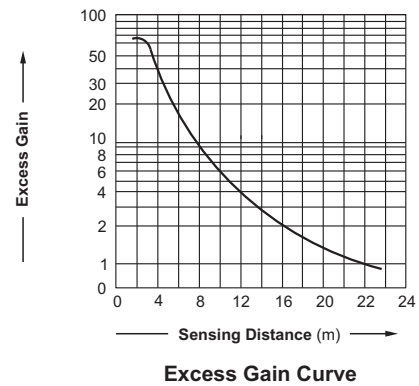

RP64 SERIES

Dimensions (Unit: mm)

Sensor Type

Cable Type

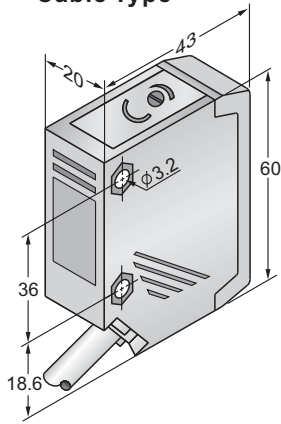

Quick Disconnect (DC: Pico style)

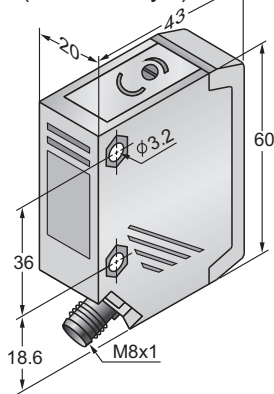

Quick Disconnect swivel 90° (DC: Euro style; AC: Micro style)

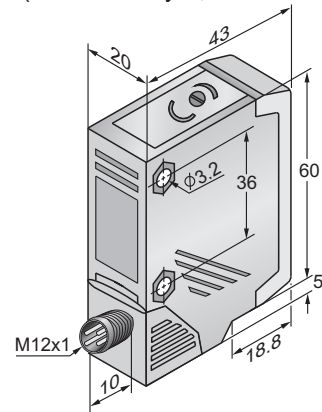

Pigtail* Type

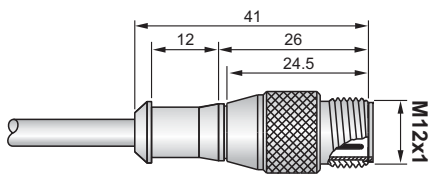

*: Please see **Pigtail Series** or our **Cables & Connectors** catalogue for more information.

MB-7047 (Mounting bracket-optional)

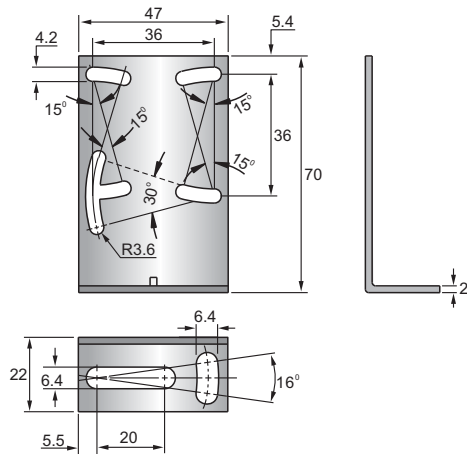

PB-8257 (Protective bracket-optional)

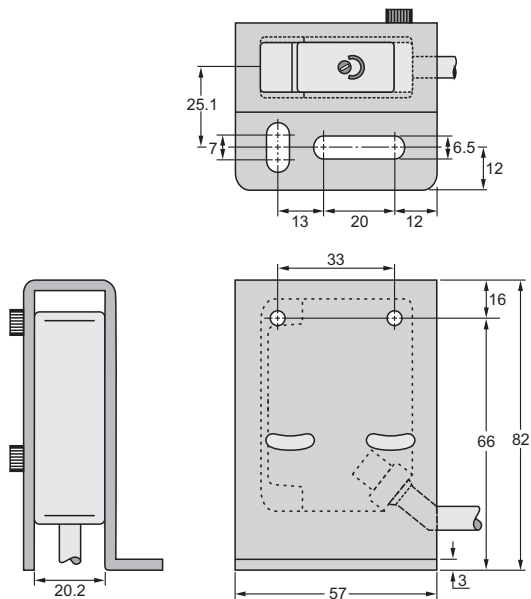

PB-10357 (Protective bracket-optional)

